

5305 and 5105 Installation Guide

LCD 2-way and 1-way models Security and Remote Start

This product is intended for installation by a professional installer only! Attempts to install this product by a person other than a trained professional may result in severe damage to a vehicle's electrical system and components.

DIRECTED[®]

© 2015 Directed, Vista, CA
N5X05 2016-01

Bitwriter®, Code Hopping™, Doubleguard®, ESP®, Fail-Safe®, Ghost Switch™, Learn Routine™, Nuisance Prevention® Circuitry, Revenger®, Silent Mode™, Soft Chirp®, Stinger®, Valet®, VRS®, and Warn Away® are all Trademarks or Registered Trademarks of Directed®.



The Bitwriter (P/N 998U) requires chip version 2.7 or newer to program this unit.

Bitwriters with a date code of 6A or older require an IC upgrade (P/N 998M). Some Bitwriters with a date code of 6B do not require the IC upgrade, refer to *Tech Tip # 1112* for more information.



Contents

Warning! Safety First.....	4
Wiring Diagram	5
Wiring Connections	6
Main Harness, White 5-pin connector	6
Auxiliary/Shutdown/Trigger Harness, White 24-pin connector.....	6
Remote Start, White 10-pin heavy gauge connector	7
Door Lock, White 3-pin connector	7
Wire Descriptions	7
Main Harness, White 5-pin connector.....	7
Auxiliary/Shutdown/Trigger Harness, 24-pin connector	8
Remote Start Heavy Gauge Harness, 10-pin connector	10
Door Lock, 3-pin connector.....	11
Connecting the Doubleguard Shock Sensor	12
Adjusting the Doubleguard Shock Sensor	13
Initializing Virtual Tach (not needed w/analog or data tach inputs)	13
Learning Analog or Data Tach (not needed with Virtual Tach)	13
Remote Start Shutdown Diagnostics	14
Pairing a Remote Control	15
Basic Remote Functions	15
Programming System Features	15
Feature Menus	17
Menu 1 - Basic.....	17
Menu 1 - Descriptions	17
Menu 2 - Descriptions	19
Menu 3 - Remote start.....	21
Menu 3 - Descriptions	21
Bitwriter - Only Options	23
Bitwriter Feature Descriptions.....	23
Reset and Deletion	24
Security Features Disable/Enable.....	25
Long Term Event History	25
Table of Zones	26
Troubleshooting: Alarm.....	26
Troubleshooting: Remote Start.....	27

Warning! Safety First



The following safety warnings must be observed at all times:

- Due to the complexity of this system, installation of this product must only be performed by an authorized Directed dealer.
- When properly installed, this system can start the vehicle via a command signal from the remote control. Therefore, never operate the system in an area that does not have adequate ventilation.

The following precautions are the sole responsibility of the user; however, authorized Directed dealers should:

- Never use a test light or logic probe when installing this unit. Always use a multimeter.
- Never operate the system in an enclosed or partially enclosed area without ventilation (such as a garage).
- When parking in an enclosed or partially enclosed area or when having the vehicle serviced, the remote start system must be disabled using the installed toggle switch. It is the user's sole responsibility to properly handle and keep out of reach from children all remote controls to assure that the system does not unintentionally remote start the vehicle.
- **USER MUST INSTALL A CARBON MONOXIDE DETECTOR IN OR ABOUT THE LIVING AREA ADJACENT TO THE VEHICLE. ALL DOORS LEADING FROM ADJACENT LIVING AREAS TO THE ENCLOSED OR PARTIALLY ENCLOSED VEHICLE STORAGE AREA MUST REMAIN CLOSED AT ALL TIMES.**

Use of this product in a manner contrary to its intended mode of operation may result in property damage, personal injury, or death. Except when performing the Safety Check outlined in this installation guide, (1) Never remotely start the vehicle with the vehicle in gear, and (2) Never remotely start the vehicle with the keys in the ignition. The user is responsible for having the parking brake/emergency brake feature of the vehicle periodically checked, wherein the vehicle must not remotely start while the car is in gear. This testing should be performed by an authorized Directed dealer in accordance with the Safety Check outlined in this product installation guide. If the vehicle starts in gear, cease remote start operation immediately and consult with the user to fix the problem immediately.

After the remote start module has been installed, test the remote start module in accordance with the Safety Check outlined in this installation guide. If the vehicle starts when performing the Neutral Safety Shutdown Circuit test, the remote start unit has not been properly installed. The remote start module must be removed or properly reinstalled so that the vehicle does not start in gear. All installations must be performed by an authorized Directed dealer.

OPERATION OF THE REMOTE START MODULE IF THE VEHICLE STARTS IN GEAR IS CONTRARY TO ITS INTENDED MODE OF OPERATION. OPERATING THE REMOTE START SYSTEM UNDER THESE CONDITIONS MAY RESULT IN PROPERTY DAMAGE OR PERSONAL INJURY. IMMEDIATELY CEASE THE USE OF THE UNIT AND REPAIR OR DISCONNECT THE INSTALLED REMOTE START MODULE. DIRECTED WILL NOT BE HELD RESPONSIBLE OR PAY FOR INSTALLATION OR REINSTALLATION COSTS.

This product should **not** be installed in any manual transmission vehicles. Installation in such vehicles may pose certain risk.

Wiring Diagram

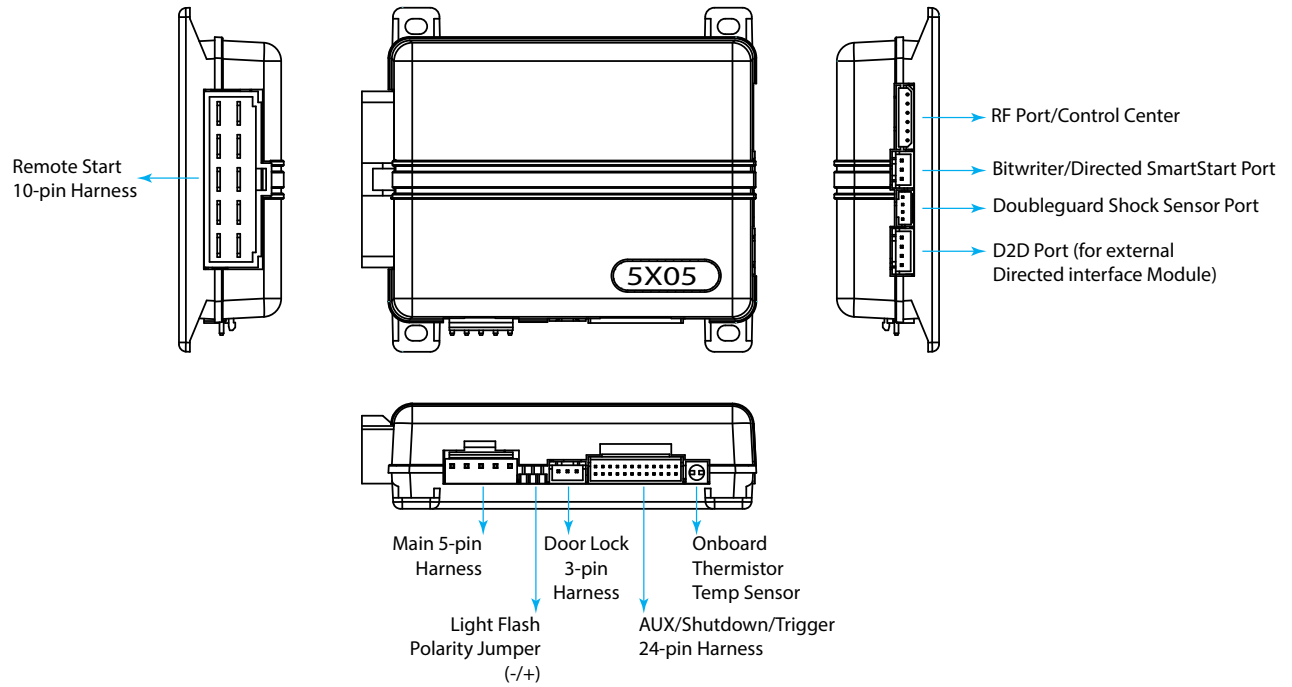

Note: (+) or (-) light flash jumper needs to be installed for the appropriate light flash polarity and is found taped to the outside on the main unit.

Wiring Connections

Main Harness, White 5-pin connector

1	BLACK	(-) CHASSIS GROUND
2	BROWN	(+) SIREN OUTPUT
3	RED	(+) FUSED 12V DC CONSTANT INPUT
4	ORANGE	(-) 500mA GWA (GROUND WHEN ARMED) OUTPUT
5	WHITE	(+)/(-) SELECTABLE PARKING LIGHT OUTPUT (FUSED)

Auxiliary/Shutdown/Trigger Harness, White 24-pin connector

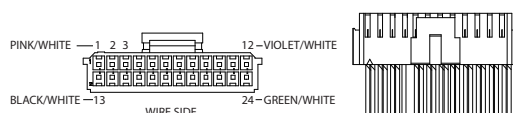

1	PNK/WHITE	(-) 200mA IGNITION 2/ACCESSORY OUTPUT
2	BLUE/WHITE	(-) 200mA 2ND STATUS /REAR DEFOGGER OUTPUT
3	RED/WHITE	(-) 200mA TRUNK RELEASE OUTPUT
4	BLACK/YELLOW	(-) 200mA DOME LIGHT OUTPUT
5	DARK BLUE	(-) 200mA STATUS OUTPUT
6	WHITE/BLACK	(-) 200mA AUX 5 OUTPUT
7	WHITE/VIOLET	(-) 200mA 2nd UNLOCK OUTPUT
8	ORANGE/BLACK	(-) 200mA AUX 6 OUTPUT
9	GRAY	(-) HOOD PIN INPUT
10	BLUE	(-) TRUNK PIN/INSTANT TRIGGER INPUT
11	WHITE/BLUE **	(-) REMOTE START ACTIVATION INPUT
12	VIOLET/WHITE	TACHOMETER INPUT
13	BLACK/WHITE*	(-) PARKING BRAKE INPUT/EMERGENCY INPUT
14	GREEN/BLACK	(-) 200mA FACTORY ALARM DISARM OUTPUT
15	GREEN	(-) DOOR INPUT
16	BROWN/BLACK	(-) 200mA HORN HONK OUTPUT
17	PINK	(-) 200mA IGNITION 1 OUTPUT
18	VIOLET	(+) DOOR INPUT
19	VIOLET/BLACK	(-) 200mA AUX 4 OUTPUT
20	BROWN	(+) BRAKE SHUTDOWN INPUT
21	VIOLET/YELLOW	(-) 200mA STARTER OUTPUT
22	GRAY/BLACK	(-) DIESEL WTS (WAIT-TO-START) INPUT
23	ORANGE	(-) 200mA ACCESSORY OUTPUT
24	GREEN/WHITE	(-) 200mA FACTORY ALARM ARM OUTPUT

* Connect this wire to one of the wires on the provided Remote Start Shutoff Switch. The other wire on the switch connects to the (-) Parking Brake/Emergency Brake wire in the vehicle. The switch must be in the ON position for the remote start to work.

** This wire not only activates the remote start, it can also be used to change feature options when programming. See Programming System Features.

Important: NEVER connect 200mA low current outputs directly to a motor or high current device WITHOUT a relay.

Remote Start, White 10-pin heavy gauge connector

1		No Connection
2	RED/BLACK	(+) FUSED 12V ACCESSORY/STARTER INPUT
3	PINK/BLACK*	(+) IGNITION 2/ACCESSORY ISOLATION WIRE # 87A key side (if required) of IGNITION 2/ACCESSORY
4	PINK/WHITE	(+) IGNITION 2 / ACCESSORY RELAY OUTPUT
5	RED	(+) FUSED 12V IGNITION 1 INPUT
6	GREEN	(+) STARTER INPUT (KEY SIDE OF THE STARTER DISABLE)
7	VIOLET	(+) STARTER OUTPUT (CAR SIDE OF THE STARTER DISABLE)
8	ORANGE	(+) ACCESSORY OUTPUT
9	RED/WHITE	(+) FUSED 12V IGNITION 2 / FLEX RELAY INPUT 87
10	PINK	(+) IGNITION 1 INPUT/OUTPUT

* This wire is only used in applications that require a specific circuit at the ignition switch to be isolated during the remote start sequence.

Door Lock, White 3-pin connector

1	BLUE	(-) 500mA UNLOCK OUTPUT
2	EMPTY	NOT USED
3	GREEN	(-) 500mA LOCK OUTPUT

D2D Harness, Red 4-pin connector

1	BLUE	D2D - TX
2	BLACK	(-) GROUND
3	GREEN	D2d - RX
4	RED	(+) 12V

Bitwriter/Directed SmartStart Harness, Black 3-pin connector

1	RED	(+) 12V
2	ORANGE	ESP 2 - RX/TX
3	BLACK	(+) 12V

Wire Descriptions

Main Harness, White 5-pin connector

Black: (-) CHASSIS GROUND

This wire is the unit's source of ground. DO NOT connect this wire to any factory ground points; they can cause noise and/or voltage drops which can affect system performance. Ground the unit and any accessories to the same point in the vehicle (preferably the kick panel). Scrape away any paint and make your own ground with a screw and a star washer.

Brown: (+) SIREN OUTPUT

This wire is the (+) output for the siren. This wire connects to the (+) input of the siren.

Red: (+) 12V CONSTANT INPUT

This wire supplies power to the unit's micro-controller. Remove the supplied fuse before connecting to the (+) terminal of the battery or another constant +12V supply. Make sure to replace the fuse when all connections have been made.

Note: Always use a fuse within 12 inches of the point from which you obtain (+) 12V. Do not use the 15A fuse in the harness for this purpose. This fuse protects the module only.

Orange: (-) GWA (GROUND WHEN ARMED) OUTPUT

This wire supplies a (-) 500mA ground output as long as the system is armed and while the remote start is active. This output ceases as soon as the system is disarmed or remote start disengages. The GWA can be hooked up to a voice module or any accessory which requires a ground when armed.

Note: The Ground When Armed during remote start feature can be programmed off (see *Anti-grind Output* in Feature Menus for more detail).

White: (+) or (-) PARKING LIGHTS OUTPUT

This wire should be connected to the parking lights wire in the vehicle. It activates when the system is armed/disarmed, remote started and when the alarm is triggered. It can be set for a (+) or (-) output by using the supplied jumper taped to the main unit. In the (+) setting the system will support up to a 10A circuit, in the (-) setting the system supplies a 200mA output. See the following diagram for setting the lights flash polarity.

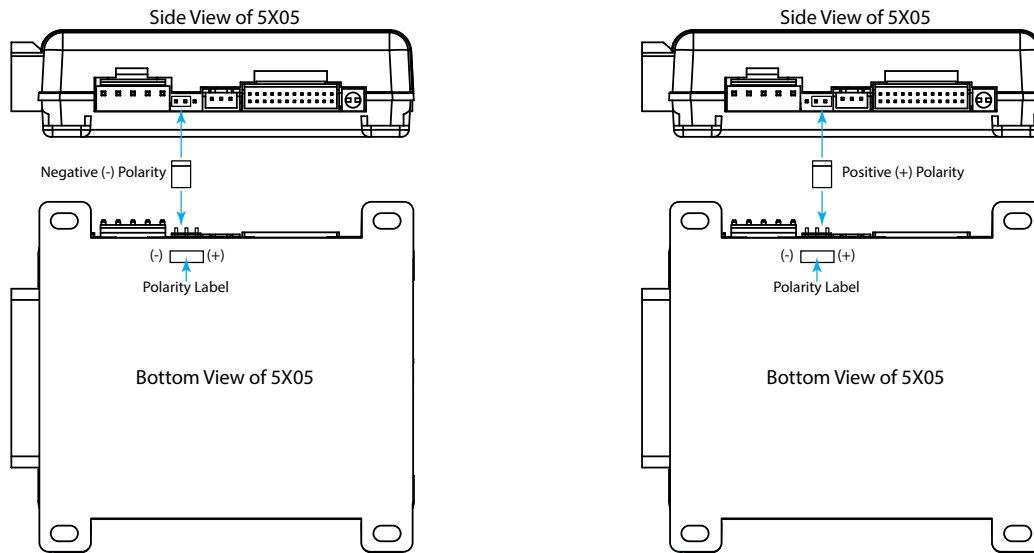

Note 1: The light flash polarity label can be found on the bottom of the 5X05 housing in the location shown in the above diagram.

Note 2: For parking light circuits that draw 10A or more, the jumper must be set to a (-) light flash output and an external SPDT relay (P/N 8617) must be used to drive the circuit in the vehicle.

Auxiliary/Shutdown/Trigger Harness, 24-pin connector

Important: Never connect 200mA low current outputs directly to a motor or high current device WITHOUT a relay.

Pink/White: (-) IGNITION 2/ACCESSORY OUTPUT

This (-) 200mA output wire works in conjunction with the Pink/White wire in the heavy gauge harness. It comes factory set as Ignition 2 and can be programmed as an Accessory output. It is typically used to activate a relay for an additional (+) Ignition or Accessory wire in the vehicle (see *2nd ignition/Acc output* in Feature Menus for more detail).

Note: Programming this wire also affects the timing of the heavy gauge Pink/White wire and vice-versa.

Blue/White: (-) 2nd STATUS/REAR DEFOGGER OUTPUT

This (-) 200mA output will activate as soon as the remote start process begins and will stay active while the remote start is on, it is typically used to activate a module or any accessory which requires a ground during the remote start sequence. This wire can also be programmed to activate a defogger circuit in the vehicle (see

2nd Status Output in Feature Menus for more detail).

Red/White: (-) AUX/TRUNK RELEASE OUTPUT

This (-) 200mA output is often used to operate a trunk/hatch release or other relay-driven functions. When the system receives the command controlling trunk release (for longer than 1.5 seconds) the Red/White wire will supply an output as long as the transmission continues.

Black/Yellow: (-) DOME LIGHT OUTPUT

This (-) 200mA output is used to drive the dome light circuit in the vehicle. This output activates when disarming/unlocking the system and when turning the ignition OFF in the vehicle (ignition controlled Dome Light is programmable ON/OFF). See *Ign-controlled Dome Light* in Feature Menus for more detail.

Dark Blue: (-) STATUS OUTPUT

This (-) 200mA output will activate as soon as the remote start process begins and will stay active while the remote start is on, it is typically used to activate an interface module or any accessory which requires a ground during the remote start sequence.

White/Black: (-) AUXILIARY 5 OUTPUT

This (-) 200mA output is used for controlling any auxiliary function such as fuel door release or a window module. This output can be programmed for different applications. (See the *AUX 5 Output* options in Feature Menus for more detail). The 2-way LCD remote control will display #5 when this channel is activated.

White/Violet: 2nd UNLOCK OUTPUT

This wire provides a 200mA output for progressive unlocking in which the driver door unlocks with the first press of the unlock button on the remote and this wire will output to unlock the remaining doors with a second press of the unlock button on the remote.

Orange/Black: (-) AUXILIARY 6 OUTPUT

This (-) 200mA output is used for controlling any auxiliary function such as fuel door release or a window module. This output can be programmed for different applications. (See the *AUX 6 Output* options in Feature Menus for more detail). The 2-way LCD remote control will display #6 when this channel is activated.

Gray: HOOD TRIGGER INPUT

This input wire is used to trigger the alarm when the vehicle's hood is opened. It will also prevent the remote start from activating if the hood is open.

Blue: (-) TRUNK TRIGGER/INSTANT TRIGGER INPUT

This input wire is used to trigger the alarm when the vehicle's trunk is opened. It can also be used as an instant trigger input for use with single zone sensors.

White/Blue: (-) REMOTE START ACTIVATION INPUT

This input wire is used to manually activate/deactivate the remote start sequence by pulsing it to ground. This input is programmable for single or double pulse activation/deactivation, (see *Activation Pulses* in Feature Menus for more detail).

Violet/White: TACHOMETER INPUT

This input wire connects to a tachometer signal in the vehicle. It provides the system with information about the engine's RPMs.

Black/White: (-) PARKING BRAKE/EMERGENCY BRAKE INPUT

This input wire connects to the parking brake/emergency brake wire in the vehicle. This wire must have a ground for the remote start to operate.

Green/Black: (-) FACTORY ALARM DISARM OUTPUT

This 200mA output is used to disarm the factory alarm and outputs when remote start is activated, when the system is disarmed and when activating the trunk release output. It typically connects to the Factory Alarm Disarm wire in the vehicle. This output can be programmed on to activate with unlock trunk release and for a single or double pulse output (see *OEM alarm Disarm* options in Feature Menus for more detail).

Green: (-) DOOR TRIGGER INPUT

This input wire is used in vehicles with a (-) switched dome light circuit or door trigger(s) and will sound the alarm when any of the vehicle's doors are opened.

Brown/Black: (-) HORN HONK OUTPUT

This wire supplies a (-) 200mA output which can be used to honk the vehicle's horn. This wire is defaulted to a pulsed output when the alarm is triggered or it can be programmed as a constant output when the alarm is triggered. This output can also be programmed to operate similar to the siren so it outputs a single pulse when locking/arming the doors with the remote, and two pulses when unlocking/disarming with the remote. (see *Horn Function* in Feature Menus for more detail).

Pink: (-) IGNITION 1 OUTPUT

This (-) 200mA output wire works in conjunction with the Pink wire in the heavy gauge harness. It is typically used to activate a relay for an additional Ignition wire in the vehicle.

Violet: (+) DOOR TRIGGER INPUT

This input wire is used in vehicles with (+) door trigger circuit and will sound the alarm when any of the vehicle's doors are opened.

Violet/Black: (-) AUXILIARY 4 OUTPUT

This (-) 200mA output is used for controlling any auxiliary function such as a fuel door release or a window module. This output can be programmed for different applications. (See the *AUX 4 Output* options in Feature Menus for more detail). The 2-way LCD remote control will display #4 when this channel is activated.

Brown: (+) BRAKE SHUTDOWN INPUT

This input wire connects to the (+) foot brake wire in the vehicle. When connected the remote start will be disabled or shutdown anytime the foot brake pedal is depressed.

Violet/Yellow: (-) STARTER OUTPUT

This (-) 200mA output wire works in conjunction with the Violet wire in the heavy gauge harness. It is typically used to activate a relay for an additional Starter wire in the vehicle.

Gray/Black: (-) DIESEL WTS (WAIT-TO-START) INPUT

This input wire connects to the (-) WTS wire in a diesel-engine vehicle and will keep the Starter output from engaging while this wire is receiving a ground.

Orange: (-) ACCESSORY OUTPUT

This (-) 200mA output wire works in conjunction with the Orange wire in the heavy gauge harness. It is typically used to activate a relay for an additional Accessory wire in the vehicle.

Green/White: (-) FACTORY ALARM ARM OUTPUT

This 200mA output is used to arm the factory alarm and outputs when the system is armed and 4 seconds after the remote start deactivates. It typically connects to the Factory Alarm Arm wire in the vehicle.

Note: The Factory Alarm Arm wire will not output a pulse when the remote start deactivates if the heavy gauge Pink wire has +12V.

Important: Never connect the 200mA low current outputs directly to a motor or high current device WITHOUT a relay.

Remote Start Heavy Gauge Harness, 10-pin connector

Empty Pin: No connection

Red/Black: (+) 12V INPUT

This wire connects to a (+) 12V source and is the power feed for the onboard Accessory and Starter relays.

Pink/Black: IGNITION 2/ACCESSORY ISOLATION WIRE

This wire is # 87A of the onboard 2nd Ignition/Flex Relay. This wire prevents having to use additional relays in vehicles which requires ignition switch isolation as shown in *Tech Tip #1077*.

Note: This wire will only be used in special situations when the ignition switch needs to be isolated and is not used in most installations.

Pink/White: IGNITION 2/ACCESSORY OUTPUT

This wire typically is connected to the Ignition 2 circuit in the vehicle. If the vehicle does not have a 2nd Ignition, it can be programmed to be used to power additional Accessory circuits in the vehicle (see *2nd Ignition/Accessory Output* in Feature Menus for more detail).

Red: (+) 12V INPUT

This wire connects to a (+) 12V source and is the power feed for the onboard Ignition relay.

Green: STARTER INPUT

This wire is # 87A of the onboard starter disable relay. After cutting the Starter wire in the vehicle, this wire will connect to the ignition switch-side of the cut starter wire. This wire is not a mandatory connection and will not prevent the remote start from activating.

Violet: STARTER OUTPUT

This wire is # 30 of the onboard starter disable relay and connects to the car side of the cut Starter wire in the vehicle. If the onboard starter disable relay is not used, connect this wire to the Starter wire in the vehicle.

Note: Some newer vehicles may not have a Starter wire at the ignition switch, therefore it may not need to be connected to the vehicle.

Orange: ACCESSORY OUTPUT

This wire connects to the Accessory circuit in the vehicle and operates as the Accessory wire at the ignition switch. When the remote start is activated this wire will activate, deactivate during the cranking cycle of the remote start, and will re-activate after the cranking cycle is done.

Red/White: (+) 12V INPUT

This wire connects to a (+) 12V source and is the power feed for the onboard Ignition 2/Accessory Relay.

Pink: IGNITION INPUT/OUTPUT

This wire connects to the main Ignition circuit in the vehicle. It will supply voltage to the Ignition circuit in the vehicle during the remote start sequence and is also the Ignition input to the unit while the remote start is not activated.

Door Lock, 3-pin connector

Blue: (-) UNLOCK OUTPUT

This (-) 500mA output connects to the (-) unlock wire in the vehicle or to a relay for vehicle specific applications. This wire will output a pulse when disarming the system. It can be programmed to unlock the vehicle when the ignition is turned OFF, and also has programmability for a double pulse output and for output duration (see *Ign-controlled Locks, Door Lock Pulses* or *Door Lock Duration* in Feature Menus for more detail).

Empty Pin: N/A

Although this connector is not populated with a wire in this position, the pin on the unit supplies a low current (+) 12V output and is utilized when using a Door Lock Relay Module (P/N 451M).

Green: (-) LOCK OUTPUT

This (-) 500mA output connects to the (-) lock wire in the vehicle or to a relay for vehicle specific applications. This wire will output a pulse when arming the system. It can be programmed to lock the vehicle when the ignition is turned on for a double pulse output and for output duration. Additionally, this output may be used as Comfort Closure in vehicles which can close the windows (and in some cases the sunroof) while holding the key to the lock position in the door key cylinder (see *Ign-controlled Locks, Door Lock Pulses, Door Lock Duration* or *Comfort Closure* in Feature Menus for more detail).

Note: The doors of the vehicle must be closed when turning the ignition ON for the ignition controlled door lock feature to work.

For wiring information regarding alternate door lock systems refer to *Tech Tip #1041 Door Lock Wiring guide* available to authorized dealers under the "Resources" tab at www.directechs.com.

Connecting the Doubleguard Shock Sensor

When connecting the Doubleguard Shock Sensor, it is important that the Green wire loop on the sensor plug is plugged into the Doubleguard Shock Sensor side and the plug with the loose green wire is plugged into the system if this is not done the sensor will not work correctly. The Green wire is a MUX (multiplex) input and is used when adding a single or dual zone sensor and can also be used to connect additional pin switches. If the Green wire is not used simply cap off the connection to make sure it does not short to ground and cause alarm trigger problems.

When adding an Doubleguard Shock Sensor in a standard installation

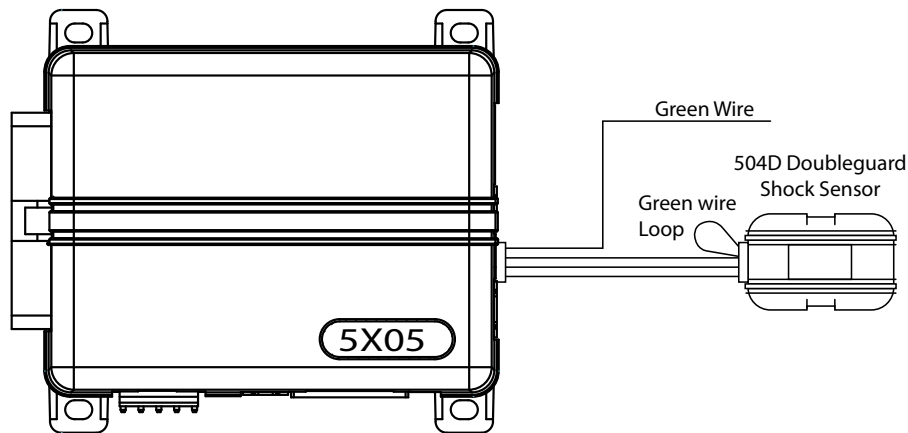

When adding an additional Single or Dual Zone Sensor

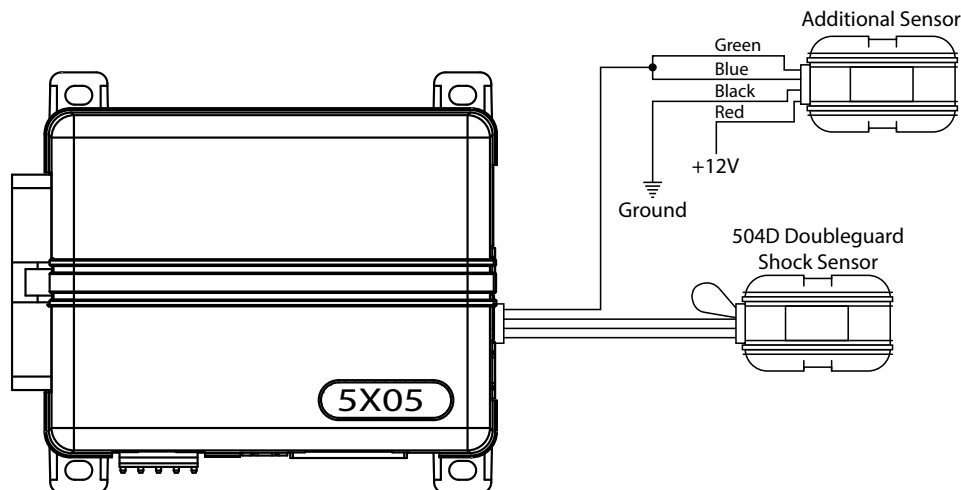

Note: When triggered, the Green wire reports Zone 4

Adjusting the Doubleguard Shock Sensor

Important! Make sure the vehicle is disarmed. The Shock Sensor sensitivity can be adjusted by using a trimmer tool/screwdriver to turn the trimpot (trimmer potentiometer).

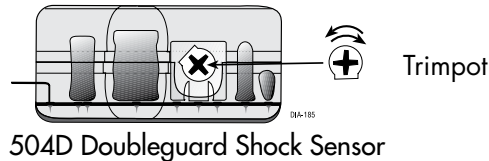

Adjusting the sensor:

1. Make sure the ignition is OFF and the system is disarmed.
2. With the sensor mounted in its permanent location, locate the trimpot on the shock sensor module and using a trimmer tool/screwdriver:
 - **Turn** the potentiometer clockwise for increased sensitivity or
 - **Turn** it counterclockwise for decreased sensitivity

Note: You can test the new setting by cautiously impacting the vehicle with increasing intensity while noting the LED status on the shock sensor. The LED turns on for a short duration for small impacts before turning off (indicating a Warn-Away trigger). The impact level required to fully trigger the alarm is indicated when the LED remains on for a longer duration before turning off.

Note: The Shock Sensor adjustment cannot be performed using the remote control or the Bitwriter.

Initializing Virtual Tach (not needed w/analog or data tach inputs)

To program Virtual Tach:

1. After the install is complete, **remote start** the engine. The programming operation may require 3 cranks of the starter before the engine starts and runs. Do not turn off the remote start if this happens, it is a normal programming operation.
2. Once the engine begins running, let it run for at least 30 seconds.
3. Using the remote control, send the remote start command to turn remote start off. Virtual Tach is programmed. To reset Virtual Tach, (see the *Reset and Deletion* section of this guide). Virtual Tach cannot be reset with the Bitwriter.

Note: Virtual Tach is not recommended for diesel vehicles.

Virtual Tach handles disengaging the starter motor during remote starting – it does not address over-rev. If the customer wants to have the over-rev protection capability, the Violet/White tach wire must be connected.

Important: After successfully learning Virtual Tach, a small minority of vehicle starters may over or under crank during remote start. The Bitwriter can be used fine tune the starter output time in 50 millisecond increments to compensate for such an occurrence.

Learning Analog or Data Tach (not needed with Virtual Tach)

To learn the tach signal:

1. **Start** the vehicle with the key. Within 5 seconds, **press** and **hold** the Control Center button.
2. After three seconds the status LED on the Control Center lights solid when a successful tach signal is learned.
3. **Release** the Control Center button.

Note: When the analog or data tachometer is programmed, the main unit automatically enters the Tachom-

eter Engine Checking Mode.

Note: Since this unit has the capability to learn the tachometer with the analog input or through D2D from an interface module, the unit gives confirmation as to which source the unit has learned from. If the tachometer analog input on the system is connected to the vehicle, the D2D tachometer input is ignored. After learning the tach and releasing the Control Center button, the system:

- Flashes the parking lights once if programmed using the analog tach wire.
- Flashes the parking lights twice if programmed using the interface module through D2D.

Important: After successfully learning Tach, a small minority of vehicle starters may over or under crank during remote start. If such an occurrence is encountered you can fine tune the starter output time by programming manually (see *Tach Mode Starter Release* in Programming System Features). **Note:** this feature is programmable only with a Bitwriter.

Remote Start Shutdown Diagnostics

If the remote start activates but fails to stay running, the remote start module has the ability to inform you of what may have caused the remote start failure. Before performing shutdown diagnostics it is important that you let the remote start shut off on its own i.e., let it attempt to start 3 times then shut down, if this is not done the unit will report the shutdown last used to shut off the remote start.

Note: Shutdown diagnostics does not report if the vehicles factory immobilizer is causing the problem.

To perform shutdown diagnostics:

1. With the ignition OFF, **press** and **hold** the Control Center button.
2. **Turn** the ignition ON and then back OFF while holding the Control Center button.
3. **Release** the Control button.
4. **Press** and release the Control Center button. The status LED flashes to report the last shutdown for one minute or until the ignition is turned on, as shown in the following table:

Status LED Flashes	Shutdown Mode
1 flash	Runtime expired
2 flashes	Over-rev shutdown
3 flashes	Low or no RPM (Tachometer Mode), or Low Battery (Voltage Mode)
4 flashes	Transmitter shutdown (or optional push button Timer Mode/Turbo Mode*)
5 flashes	(-) Hood shutdown
6 flashes	(+) Brake shutdown
7 flashes	Parking Brake/Emergency Brake shutdown
8 flashes	WTS (Wait-to-start) input timed out

- * Timer Mode error: Ignition is on or shutdown input is active when activating timer mode.
Turbo Mode error: Turbo mode is programmed off, engine is not on or shutdown input is active.



Pairing a Remote Control

1. **Open** a door
2. **Turn** key to the ON position
3. Within five seconds, **press** and release the Control Center button one time.
4. Within five seconds, **press** and **hold** the Control Center button. The LED will flash one time and the siren chirps to confirm entry into remote programming.
5. **Press** the  button on each remote control to be programmed. The siren will chirp to confirm when each remote has been programmed.
6. **Release** the Control Center button and **turn** the key to OFF.

To exit pairing mode, **press** and release the  button. The pairing routine also exits if any of the following occurs:

- The open door is closed
- The ignition is turned off
- There is no activity for 30 seconds
- The control center button is pressed too many times

Basic Remote Functions





Button	Function
	ARM
	DISARM
	REMOTE START
AUX	TRUNK RELEASE
P*	PROGRAMMING

* Only applicable to LCD 2-way remote control.

Note: See *Owner's Guide* for more details.

Programming System Features

The System Features Learn Routine dictates how the unit operates. It is possible to access and change most of the feature settings using the Control Center button.

1. **Open** a door.
2. **Turn** the ignition on, then off.
3. **Select** a Menu. **Press** and **hold** the Control Center button. The number of siren chirps indicates the menu number. 1 LED flash and chirp indicates Menu 1, 2 LED flashes and chirps - Menu 2 and 3 LED flashes and chirps for Menu 3.
4. When the desired menu chirps are heard, **release** the Control button.
5. **Select** a Feature. **Press** and release the Control Center button the number of times corresponding to the feature you desire to change. Then, **press** and **hold** one more time to select the features.
6. Program the Feature. While still **holding** the Control Center button, you can program the feature using the remote control or by pulsing a (-) on the 24 pin White/Blue Activation Input wire.
 - **With the remote:**
For features with only two options;  = option 1, while  = option 2.
For features with more than two options;  selects the options in ascending order, while  selects them in descending order.
 - **With White/Blue (-) Activation Input:**
Each time this input is pulsed with a (-) the next available setting will be chosen.

Note: The Control Center LED will flash and the siren will chirp the number of times equal to the option chosen.

Once a feature is programmed:

- Other features can be programmed within the same menu.
- Another menu can be selected.
- The Learn Routine can be exited if programming is complete.

To access another feature in the same menu:

1. **Press** and release the Control Center button the number of times necessary to advance from the feature you just programmed to the next one you want to program.
2. Then **press** the Control Center button once more and **hold** it.

To select another menu:

1. **Press** and **hold** the Control Center button.
2. After three seconds, the unit advances to the next menu and the siren chirps, indicating which menu has been accessed.

The learn routine exits if any of the following occurs:

- The open door is closed.
- The ignition is turned On.
- There is no activity for 30 seconds.
- The Control Center button is pressed too many times.

Feature Menus

Default settings are in **bold** type.

Menu 1 - Basic

Menu Item	One-chirp setting	Two-chirp and up setting
1	System Arming Mode: Active Arming	Passive Arming
2	Arm/Disarm Chirps: On	Off
3	Ignition Controlled Lock: On	Off
4	Ignition Controlled Unlock: On	Off
5	Door Locking Mode: Active	Passive
6	Panic with Ignition: On	Off
7	Door Lock Output Duration (in seconds): 0.8 sec.	3.5 (2), 0.4 (3) seconds
8	Forced Passive Arming: On	Off
9	AED (Automatic Engine Disable): On	Off
10	AWD (Armed When Driving): On	Off
11	Code Hopping: On	Off
12	Horn Honk Mode: Pulsed	Constant
13	Horn Function (in milliseconds): Full Alarm Only	Siren Function - Chirp Length: 20 ms (2), 30 ms (3), 40 ms (4), 50 ms (5)
14	Comfort Closure 1: ON	Comfort Closure: OFF (2), Comfort Closure 2 (3)

The features of the system are described below. Features that have additional settings when programming with the Bitwriter only, are indicated by the following icon: 

Menu 1 - Descriptions

1. System Arming Mode

1. Active: The transmitter must be used to arm the system.
2. Passive Arm: After exiting the vehicle the system will automatically arm.

2. Arm/Disarm Chirps

1. On: Arm, disarm chirps are active.
2. Off : Arm, disarm chirps are defeated.

3. Ignition Controlled Lock

1. Off: The door lock output will not output when the ignition is turned off.
2. On: The door lock output will activate when the ignition is turned on.

4. Ignition Controlled Unlock

1. Off: The door unlock output will not output when the ignition is turned on.
2. On: The door unlock output will activate when the ignition is turned on.

5. Door Locking Mode:

If passive arming is selected in Feature 1-1, then the system can be programmed to either lock the doors when passive arming occurs, or only lock the doors when the system is armed via the transmitter.

1. Active locking: The system will not lock the doors when it passively arms.
2. Passive locking: The system will lock the doors when it passively arms.

Note: Remember, when passive arming is selected, the unit will chirp 20 seconds after the last door is closed. The system does not actually arm or lock the doors until 30 seconds after the door has been closed.

6. Panic With Ignition On:

1. Panic with ign On: The Panic output can be activated at any time.
2. No panic with ign On: The Panic output can be activated only when the ignition is off.

7. Door Lock Output Duration:

1. 0.8 sec.: The door lock/unlock output pulses will be 800 milliseconds in duration.
2. 3.5 sec.: The door lock/unlock pulses will be 3.5 seconds in duration.
3. 0.4 sec.: The door lock/unlock pulses will be 400 milliseconds in duration.

8. Forced Passive Arming:

1. On: Forced passive arming will ensure that the system will passively arm, even if a zone is left open. Forced Passive Arming occurs one hour after the ignition is turned off.
2. Off: The system will not passively arm if a zone is left open.

9. AED (Automatic Engine Disable):

1. On: The Orange GWA (Ground-When-Armed) output will activate 30 seconds after the ignition is turned off. The LED will flash at half its normal rate when the ignition is turned off to indicate that AED is active and will interrupt the starter in 30 seconds. AED does not occur in Valet mode and can be bypassed using the emergency override procedure. The transmitter can be used to disarm AED, however, the system must be armed and then disarmed, using the transmitter, to disarm AED.
2. Off: The Orange GWA (Ground-When-Armed) output will not activate 30 seconds after the ignition is turned off.

10. AWD (Armed While Driving):

1. On: The system can be armed with the ignition on. When armed, the GWA is not active and the sensors are bypassed. The door triggers will remain active.
Note: turning off the ignition will disarm the system.
2. Off: The system cannot be armed when the ignition is on.

11. Code Hopping:

- On/Off: The system uses a mathematical formula to change its code each time the transmitter and receiver communicate. This makes the group of bits or "word" from the transmitter very long. The longer the word is, the easier it is to block its transmission to the unit. Disabling the Code Hopping feature lets the receiver ignore the Code Hopping part of the transmitted word.

12. Horn Honk Mode:

1. Pulsed: The horn honk output will be pulsed when the system is triggered.
2. Constant: The horn honk output will be constant when the system is triggered.

13. Horn Function:

1. Full Alarm Only: The horn output will pulse only during full trigger events.
2. Siren Function 20/30/40/50 milliseconds: The horn output will emulate the siren output with selectable chirp output timing to compensate for OEM horn inefficiency.

14. Comfort Closure:

1. Comfort Closure 1 On: The door lock pulse (or 2nd pulse for double pulses) will remain on for 20 seconds.
2. Comfort Closure Off: Comfort Closure is defeated when arming.
3. Comfort Closure 2: 800 milliseconds following the last door lock pulse (or 2nd pulse for double pulses); the door lock output will turn on again for 20 seconds.

To test if the car has the comfort closure:

1. **Insert** the key into the drivers door key cylinder.
2. **Turn** the key to the lock position and **hold** for about 10 seconds. Some cars require that you **turn** the key once, release, and then **turn** and **hold** into the lock position.
3. If Comfort Closure is available, the windows (and in some cars the sunroof) close.

Important: Comfort Closure can only be used on cars that have the capability of closing the windows (and on some cars the sunroof as well) with the key in the door cylinder.

Menu 2 - Advanced

Menu Item	One-chirp setting	Two-chirp and up setting
1	Siren Duration: 30 second	60 second*
2	NPC (Nuisance Prevention Circuitry): On	OFF
3	Progressive Door Trigger: On	Off
4	Valet Switch Pulse Count: 1	2-5 pulses
5	Door Trigger Error Chirp: On	OFF
6	Ignition Controlled Domelight: On	OFF
7	Unlock Output: 1 pulse	2 pulses
8	Lock Output: 1 pulse	2 pulses
9	OEM Alarm Disarm With Trunk Release: On	OFF
10	OEM Alarm Disarm Output with Unlock	Before Unlock (2), Remote Start Only (3)
11	OEM Alarm Disarm Pulses: 1 pulse	2 pulses
12	AUX 4 Output Type: Validity **	Latched (2), Latch reset with ignition (3), 30-sec timed (4), 60-sec (5), 90-sec (6)*
13	AUX 4 Linking: None	Arm (2), Disarm (3), Remote Start (4)
14	AUX 5 Output Type: Validity **	Latched (2), Latch reset with ignition (3), 30-sec. timed (4), 60-sec (5), 90-sec (6)*
15	AUX 5 Linking: None	Arm (2), Disarm (3), Remote Start (4)
16	AUX 6 Output Type: Validity **	Latched (2), Latch reset with ignition (3), 30-sec. timed (4) 60-sec (5), 90-sec (6)*
17	AUX 6 Linking: None	Arm (2), Disarm (3), Remote Start (4)

* Additional settings using the Bitwriter.

** On the Bitwriter AUX 4 is labeled as "AUX 2", AUX 5 as "AUX 3", and AUX 6 as "AUX 4".

Menu 2 - Descriptions



1.  Siren Duration (Brown wire on 5-pin harness):
 1. 30 sec.: The siren output for full trigger activations and Panic mode is 30 seconds.
 2. 60 sec.: The siren output for full trigger activations and Panic mode is 60 seconds.
- 2.- NPC (Nuisance Prevention Circuitry):
 1. On: Sensors that trigger excessively will be defeated until they have been stable for more than one hour.
 2. Off: Sensors will not be defeated if triggered excessively.
3. Progressive Door Trigger (Green or Violet wire on 24-pin harness):
 1. On: When the door is opened with the system armed, the siren will chirp 10 times prior to the full triggered sequence.
 2. Off: The full siren output will occur the moment the door is opened.
4. Valet/Override Switch Pulse Count:
 - 1-5: Sets the number of presses (1-5) on the Control Center Button required to override the alarm system.
5. Door Trigger Error Chirp:
 1. On: If the door trigger is active when arming, the siren will emit an additional chirp as an alert.
 2. Off: An active door trigger when arming will not create an alert output.
6. Ign-controlled Domelight:
 1. On: The system will turn on the dome light for 30 seconds when the ignition is turned off.
 2. Off: The system does not turn on the domelight when the ignition is turned off.

Note: The domelight supervision option must be installed.

7. Unlock Output (Blue wire on 3-pin harness):
 1. 1 pulse: The unlock output pulses once.
 2. 2 pulses: The unlock output pulses twice.
8. Lock Output (Green wire on 3-pin harness):
 1. 1 pulse: The lock output pulses once.
 2. 2 pulses: The lock output pulses twice.
9. OEM Alarm Disarm w/Trunk Release:
 1. On: The Factory Alarm Disarm wire will pulse as programmed when the Trunk release output is activated.
 2. Off: The Factory Alarm Disarm wire will not pulse when the Trunk release output is activated.
10. OEM Alarm Disarm Output (Green/Black wire, 24-pin harness):
 1. With Unlock: In the default setting the factory alarm is disarmed any time the button(s) controlling Unlock is pressed and when remote start is activated.
 2. Before Unlock: Output to disarm the factory alarm activates before unlock and when remote start is activated.
 3. Remote Start Only: Output disarms the factory alarm before remote start is activated.
11. OEM Alarm Disarm Pulses (Green/Black wire, 24-pin harness):
 1. 1 Pulse: The OEM Alarm Disarm wire will pulse once per operation.
 2. 2 Pulses: The OEM Alarm Disarm wire will pulse twice per operation.

12.  AUX 4 Output Type (Violet/Black on the 24-pin harness):
This wire provides a (-) 200mA output whenever the transmitter button(s) controlling AUX 4 is pressed. This output can be programmed to provide the following types of outputs:
 1. Validity: Output that will send a signal as long as the transmission is received.
 2. Latched: Output that will send a signal when the AUX button is pressed and will continue until the same button(s) is pressed again.
 3. Latched, Reset with Ignition: Similar to the latched output, this type of output turns on the first time the AUX button is pressed and turns off the next time the same button is pressed. This type of output additionally stops and resets whenever the ignition is turned on and then off.
 4. 30 (60 or 90) second Timed: Output that will send a continuous signal for 30, 60 or 90 seconds.

Note: All auxiliary channel timed outputs can be programmed using the Bitwriter® (1-90 seconds).

13. AUX 4 Linking:
 1. Linking None: Feature not enabled.
 2. Arm: When programming to validity or timed output this can be programmed to activate when arming
 3. Disarm: When programming to validity or timed output this can be programmed to activate when disarming
 4. Remote Start: When programming to validity or timed output this can be programmed to activate when remote starting with the transmitter.
14.  AUX 5 Output Type (White/Black on the 24-pin harness): Validity (1)/Latched (2)/Latched Reset With Ignition (3)/30(4),60 (5) And 90 (6) Sec Timed Output:
AUX 5 can be programmed for these output configurations. The unit is set to the default validity output. To change the configuration, use the two-chirp setting to toggle through the different configurations. Refer to feature 12 for additional detail.
15. AUX 5 Linking: None(1)/Arm (2), Disarm (3), Remote Start(4): Refer to feature 13 for additional detail.
16.  AUX 6 Output Type (Orange/Black on the 24-pin harness): Validity (1)/Latched (2)/Latched Reset With Ignition (3)/30, 60 And 90 Sec Timed Output:
AUX 6 can be programmed for these output configurations. The unit is set to the default validity output. To change the configuration, use the two-chirp setting to toggle through the different configurations. Refer to feature 12 for additional detail.
17. AUX 6 Linking: None(1)/Arm (2), Disarm (3), Remote Start (4): Refer to feature 13 for additional detail.



Menu 3 - Remote start

Menu Item	One-chirp setting	Two-chirp and up setting
1	Engine Checking Mode: Virtual Tach	Voltage (2), OFF (3), Tachometer (4)
2	Remote Start Runtime: 12 minutes	24 minutes (2), 60 minutes* (3)
3	Parking Light Output: Flashing	Constant
4	Cranking Time: 0.6 seconds	0.8 (2), 1.0 (3), 1.2 (4), 1.4 (5), 1.6 (6), 1.8 (7), 2.0 (8), 4.0 (9) second(s)
5	Activation Pulse: 1	2
6	2nd Ignition/Acc. Output: Ignition	Accessory
7	Acc. State During WTS (Wait-to-Start): Off	On
8	2nd Status Output: Normal	Rear Defogger: Latch 10 minutes. (2), Rear Defogger: Pulse (3)
9	Anti Grind Output: On	Off
10	Diesel Start Delay (in seconds): WTS (Wait-to-Start) input	Timed 15 (2), 30 (3), 45 (4) seconds*
11	Timer Mode Runtime: 12 minutes	3 (2), 6 (3), 9 (4) minutes*
12	Timer Mode Start Type: Timed Starts	Temp Starts
13	Short Engine Runtime (Turbo): 1 minute	3 (2), 5 (3), 10 (4) minutes

*Additional settings when using the Bitwriter

Menu 3 - Descriptions

1. Engine Checking Mode:
 1. Virtual Tach: Battery voltage drop/rise during cranking determines when the starter output is released. During runtime, constant voltage level is monitored to determine if the engine is running.
 2. Voltage: Starter output during cranking is a programmed duration (Set in Cranking Time). During runtime, constant voltage level is monitored to determine if the engine is running.
 3. Off: Starter output during cranking is a programmed duration (Set in Cranking Time). The remote start will keep the ignition/accessories active for the programmed runtime whether the engine is running or not.
 4. Tachometer: Tachometer input signal during cranking and runtime to determine when the starter output is released and if the engine is running.
2.  Run Time:
 - 12/24/60 minutes: Sets engine runtime during normal remote start operations.
3. Parking Light Output (White wire on 5-pin harness):
 1. Flashing: The lights will pulse on/off during remote start.
 2. Constant: The lights will turn on solid during remote start.
4. Cranking Time:
 - 0.6/0.8/1.0/1.2/1.4/1.6/1.8/2.0/4.0 seconds: Determines the starter output duration during cranking for the 'Voltage' and the 'Off' Engine Checking Mode options.
5. Activation Pulse Count (White/Blue on 24-pin connector):
 - 1/2 pulses: Sets the number of remote control commands received or Activation Input pulses required to activate and de-activate remote start.
6. 2nd Ignition/Accessory Output (Pink/White on the 10-pin harness):
 - This will allow the Pink/White wire to be used as a 2nd ignition or an accessory. The default is 2nd ignition.

7. Accessory State During Wait-To-Start Off/On (Orange wire on 10-pin harness):
 - This feature will allow the selection of the accessory output to be ON or OFF during WTS.
8. Status Output (Dark Blue wire on 24-pin harness):
 1. Status Normal: The output will activate before the ignition outputs turn on, and de-activate after they turn off during remote start.
 2. Latch Rear Defogger: The output activates 10 seconds after start if the temperature at the main unit is below 55F°. It turns off after 10 minutes or upon remote start off.
 3. Pulse Rear Defogger: The output activates (for 800 ms) 10 seconds after start if the temperature at the main unit is below 55F°.
9. Anti-grind Output (Orange wire on 5-pin harness):
 - On/Off: With the anti-grind On (default) the GWA (Ground-When-Armed) output will be active during remote start operation. If accessories such as a voice module or window module are added to the unit, it may be necessary to program this feature off.
10.  Diesel Start Delay (Gray/Black wire on 24-pin harness):
 1. WTS (Wait-to-Start) Input: (-) Input on the Gray/Black WTS wire will delay the starter output until the ground ceases.
 2. Timed 15/30/45 seconds: Delays the starter output per the selected option, the WTS wire does not function.
11.  Timer Mode Runtime:
 - 12, 3, 6, 9 Minutes: Selects the time in minutes that the system will operate the engine until the system "times out". Using the Bitwriter, the run time can be programmed for any duration from 1-16 minutes.
12. Timer/Temp Mode Start Type:
 1. Timed Start Mode: The system will start every three hours (a maximum of six times) until canceled by the brake, hood, turning on the ignition, or parking brake/emergency brake shut-down wires.
 2. Temperature Start Mode will not start the vehicle unless the interior temperature of the vehicle is less than zero degrees fahrenheit. The Temperature Start Mode will exit after 18 hours.
13. Short Engine Runtime/Turbo Mode:
 - 1/3/5/10 Minutes: When Turbo Mode is activated, the engine will run for the duration set per the selected option.

Bitwriter - Only Options



If programming with the Bitwriter, the Learn Routine can be locked or unlocked. If the Learn Routine has previously been locked, it must be unlocked with Bitwriter - this cannot be done manually with the Control Center button.

The Bitwriter  gives you access to a wider range of system options. These features and the adjustments that may be programmed are described in the table below.

Menu Item	Feature	Default	Options
1	Siren Duration (in seconds)	30 sec.	1-180 sec.
2	AUX 4 Timed Output (in seconds)*	30 sec.	1-90 sec.
3	AUX 5 Timed Output (in seconds)*	30 sec.	1-90 sec.
4	AUX 6 Timed Output (in seconds)*	30 sec.	1-90 sec.
5	Engine Runtime (in minutes)	12 min.	1-60 min.
6	Diesel Start Delay (in seconds)	15 sec.	1-90 sec.
7	Timer Mode Runtime (in minutes)	12 min.	1-16 min.
8	Virtual Tach Fine Tune (in milliseconds)	Not initialized	0-1000 in 50 ms increments
9	Transmitter Programming	Unlocked	Locked
10	Feature Programming	Unlocked	Locked

* On the Bitwriter AUX 4 is labeled as "AUX 2", AUX 5 as "AUX 3", and AUX 6 as "AUX 4".

Note: The "Zap" feature on the Bitwriter does not reset the Virtual Tach or Security Features Enabled/Disabled settings.

Bitwriter Feature Descriptions

1. Siren Duration:

Sets the siren output for full trigger activations from 1-180 seconds.

2. AUX 4 Timed Output:

Sets the output duration in 1 second intervals up to 90 seconds.

3. AUX 5 Timed Output:

Sets the output duration in 1 second intervals up to 90 seconds.

4. AUX 6 Timed Output:

Sets the output duration in 1 second intervals up to 90 seconds.

5. Engine Runtime:

Sets engine runtime during normal remote start operations from 1-60 minutes.

6. Diesel Start Delay:

Sets the WTS delay before engine crank in 1 second intervals from 1-90 seconds for diesel engine vehicles.

7. Timer Mode Runtime:

Sets the duration of runtime when the engine is started by the Timer Mode from 1-16 minutes.

8. Virtual Tach Fine Tune:

Adds or subtracts starter crank time in Virtual Tach mode in order to overcome engine types that short crank or over-crank on the first start attempt.

9. Transmitter Programming:

Locks and unlocks the user's ability to enter the Remote Control Pairing/Reset menu and manually change any functions using the Control Center button.

10. Feature Programming:

Locks and unlocks the user's ability to enter the Feature Menus and manually change the main unit programming using the Control Center.

Reset and Deletion

If a feature or Virtual Tach needs to be reset or the remote controls need to be deleted, use the following procedure.

1. **Open** a door. (The 24-pin harness Green wire or the Violet wire must be connected).
2. **Turn** the ignition to the ON position (The heavy gauge Pink wire must be connected).
3. Within 10 seconds, **press** and release the Control Center button: two times if you want to delete remote controls, three times to reset features or four times to reset virtual tach. These function steps are described next.

Step 2:

Delete remotes: This feature erases all remote controls from the memory of the security system. This is useful in cases when a customer's remote is lost or stolen.

Note: This does not reset the programmed features of the security system or reset the Virtual Tach setting.

Step 3:

Reset Features: This resets features all of the security system to the factory default settings.

Note: This feature does not delete the remote controls from the security system or reset the Virtual Tach setting

Step 4:

Virtual Tach Reset: Deletes all previously learned values for Virtual Tach, and on the next remote start sequence the unit begins Virtual Tach initialization.

Note: The "Zap" feature on the Bitwriter does not reset the Virtual tach setting.

4. Once you have selected the function step, **press** the Control Center button once more and **hold** it. The LED flashes and the siren chirps to confirm the selected functional step. Do not release the Control Center button.
5. While still **holding** the Control Center button, **press** the  button on the remote control. The unit chirps to confirm that the feature has been successfully reset.
6. **Release** the Control Center button and **turn** the key Off.
7. The siren will emit one long chirp confirming that the Reset and Delete mode has been exited.

The Reset and Delete mode exits if any of the following occurs:

- The open door is closed.
- The ignition is turned off.
- There is no activity for 30 seconds.
- The Control Center button is pressed too many times.

Security Features Disable/Enable

The system has the ability to function as a security/remote start system or as a keyless/remote start system by disabling or enabling the security features/functions. The default setting is **Enabled**.

To program the feature:

1. **Open** a door.
2. **Turn** the ignition on, then off.
3. **Press** and **hold** the Control Center button until the Control Center LED flashes three times and the siren (if connected) chirps three times (the system will enter Feature Menus 1 & 2 and continue to menu 3).
4. **Release** the Control Center button.

Note: If the Control Center button is released and then pressed again, the system will enter the *Programming System Feature Menus*.

5. Within 15 seconds, **simultaneously press** the  and  buttons of a programmed remote control.
6. The siren (if connected) will chirp and the parking lights will flash as listed below.

1. Flash/chirp: Security features DISABLED
2. Flashes/chirps: Security features ENABLED

Security features disabled will disable all security operations of the system, including but not limited to the following:

- Multi Level Arming
- Sensor Warn-Away
- Full Trigger Operation
- AWD (Armed While Driving)
- AED (Automatic Engine Disable)

Note: Disabled features with programmable options can still be programmed manually or with the Bitwriter but will not operate until the Security Features have been enabled.

The Security Features Disable/Enable routine exits if the following occurs:

- The open door is closed.
- The ignition is turned On.
- There is no activity for 15 seconds.
- The Control Center button is pressed too many times.

Long Term Event History

The system stores the last two full triggers in memory. These are not erasable. Each time the unit sees a full trigger, the older of the two triggers in memory is replaced by the new trigger. To access long term event history:

1. With the ignition Off, **press** and **hold** the Control Center button.
2. **Turn** the ignition On.
3. **Release** the Control Center button.
4. Within five seconds, **press** and release the Control Center button. The status LED flashes in groups indicating the last two zones that triggered the unit for one minute or until the ignition is turned off. Refer to *Table of Zones* for more information.

Note: The Warn Away triggers are not stored to memory and is not reported.

Table of Zones

A zone is represented by the number of status LED flashes used by the system to identify a particular type of input.

Zone	Description	Input Description
1	Trunk Pin	24-pin Harness Blue wire
2	Instant trigger: a heavier impact detected by the Doubleguard Shock Sensor	Shock Sensor.
3	Door switch trigger	24-pin Harness Green or Violet wire
4	Instant trigger: For optional sensors	Optional MUX port Green wire
5	Ignition trigger	10-pin Harness Pink wire
6	Hood Pin	24-pin Harness Gray wire

Troubleshooting: Alarm

Shock sensor doesn't trigger the alarm:

1. Was the shock sensor adjusted before it was mounted? If so re-adjust the sensor.
2. Has the NPC system been triggered? If so, you hear 5 chirps when disarming. To check this, turn the ignition key on and off to clear the NPC memory, and then retest the shock sensor. For a detailed description of NPC, see *Nuisance Prevention Circuitry* section of the owners guide.

Door input does not immediately trigger full alarm. Instead, chirps are heard for the first 3 seconds:

- That's how the progressive two-stage door input works! This is a feature of this system even if the door is instantly closed again, the progression from chirps to constant siren continues.

Closing the door triggers the system, but opening the door does not:

- Have you correctly identified the type of door switch system? This happens often when the wrong door input has been used.

System does not passively arm until it is remotely armed and then disarmed:

1. Is passive arming programmed ON?
2. Are the door inputs connected? Is the 24-pin harness Blue wire connected to the door trigger wire in the vehicle? Either the 24-pin harness Green or Violet wire should be used instead.

Door input does not respond with the progressive trigger, but with immediate full alarm:

- Does the Status LED indicate that the trigger was caused by the shock sensor? (See *Table of Zones* section of this guide.) The Doubleguard Shock Sensor, if set to extreme sensitivity, may be detecting the door unlatching before the door switch sends its signal. Reducing the sensitivity can solve this problem.

Door locks operate backwards.

- This unit has easily-reversed lock/unlock outputs. Recheck wire connections to see if you have reversed these.

Troubleshooting: Remote Start

The remote start will not activate the remote start:

1. Check shutdown diagnostics. Sometimes the remote start shutdown diagnostics will report if there is an active shutdown.
2. Is the parking brake/emergency brake input wire connected to the parking brake/emergency brake wire in the vehicle and is the parking brake/emergency brake set?
3. Is the remote programmed to the system?
4. Can the remote start be activated manually by applying a ground pulse to the 24 pin harness White/Blue activation input?
5. Check the harnesses and their connections. Make sure that the harnesses are completely plugged into the remote start module. Make sure there are good connections to the vehicle wiring.
6. Check voltage and fuses on the main harness and on the heavy gauge remote start harness.

The remote start will activate, but the starter never engages:

1. Check for voltage on the Violet starter wire two seconds after the remote start becomes active. If there is voltage present, skip to Step 8. If there is not voltage present, advance to Step 2.
2. Check the 30A fuses.
3. If the Gray/Black WTS (Wait-to-Start) wire is detecting ground upon activation, the starter will not crank.
4. Is the tach wire connected? If so disconnect it and remote start the vehicle to see if the Violet wire sends out voltage. If you get voltage you will need to go to an alternate tach source, the tach wire you are currently on has a voltage spike upon ignition power up which can cause the remote start to not send out the crank voltage.
5. Is the vehicle a Chrysler or GM with a multiplexed starter wire? The vehicle will not crank if the resistance is incorrect on the multiplexed accessory/starter wire.
6. Is the vehicle a GM? If so the Brown 2nd accessory needs to be powered up on some of the vehicles for the vehicle to crank.
7. Make sure the Violet starter wire is connected on the starter side of the optional starter disable/anti-grind relay.
8. Does the vehicle have an immobilizer? Some immobilizer systems will not allow the vehicle to crank if active.
9. Check connections. The heavy gauge remote start input wires on the heavy gauge 10-pin connector should have a solid connection. "T-taps" or "scotch locks".

The vehicle starts, but immediately dies:

1. Does the vehicle have an immobilizer? The vehicle's immobilizer can cut the fuel and/or spark during unauthorized starting attempts.
2. Is the remote start programmed for Virtual Tach or Voltage Sense? If so, the crank time may not be set high enough. Voltage Sense will not work on some vehicles.
3. Is the remote start in Tach Mode? If so has the tach been programmed to the system?
4. Check diagnostics. Sometimes a shutdown will become active during cranking or just after cranking.

The vehicle starts, but the starter keeps running:

1. Is the system programmed for Engine Checking Off, Virtual Tach, or Voltage Sense? When programmed for either of these features, the engine cranks for the pre-programmed crank time regardless of how long it takes for the vehicle to actually start. Adjust to a lower cranking time.
2. Was the Tach Learn successful? The LED must light solid and bright to indicate a successful learn.
3. Make sure that there is a tach signal at the Violet/White tach input wire of the remote start. If there is not a tach signal, recheck the connection to the vehicle's tach wire and make sure the wire is not broken or shorted to ground leading to the remote start.
4. Is an ignition or accessory output wire connected to the starter wire of the vehicle? Verify the color of the starter wire in the vehicle and confirm that an ignition or an accessory output is not connected to that wire.

The vehicle starts, but will only run for 10 seconds:

1. Is the remote start programmed for voltage sense? If this does not work, a tach wire should be

- used.
2. Check shutdown diagnostics:

The climate control system does not work while the unit is operating the vehicle:

1. Either the wrong accessory wire is being energized or more than one ignition or accessory wire must be energized in order to operate the climate control system.
2. If the vehicle has an electronic climate control system some will reset when the key is turned off and then back on, unfortunately this is a function of the vehicle and cannot be bypassed.